

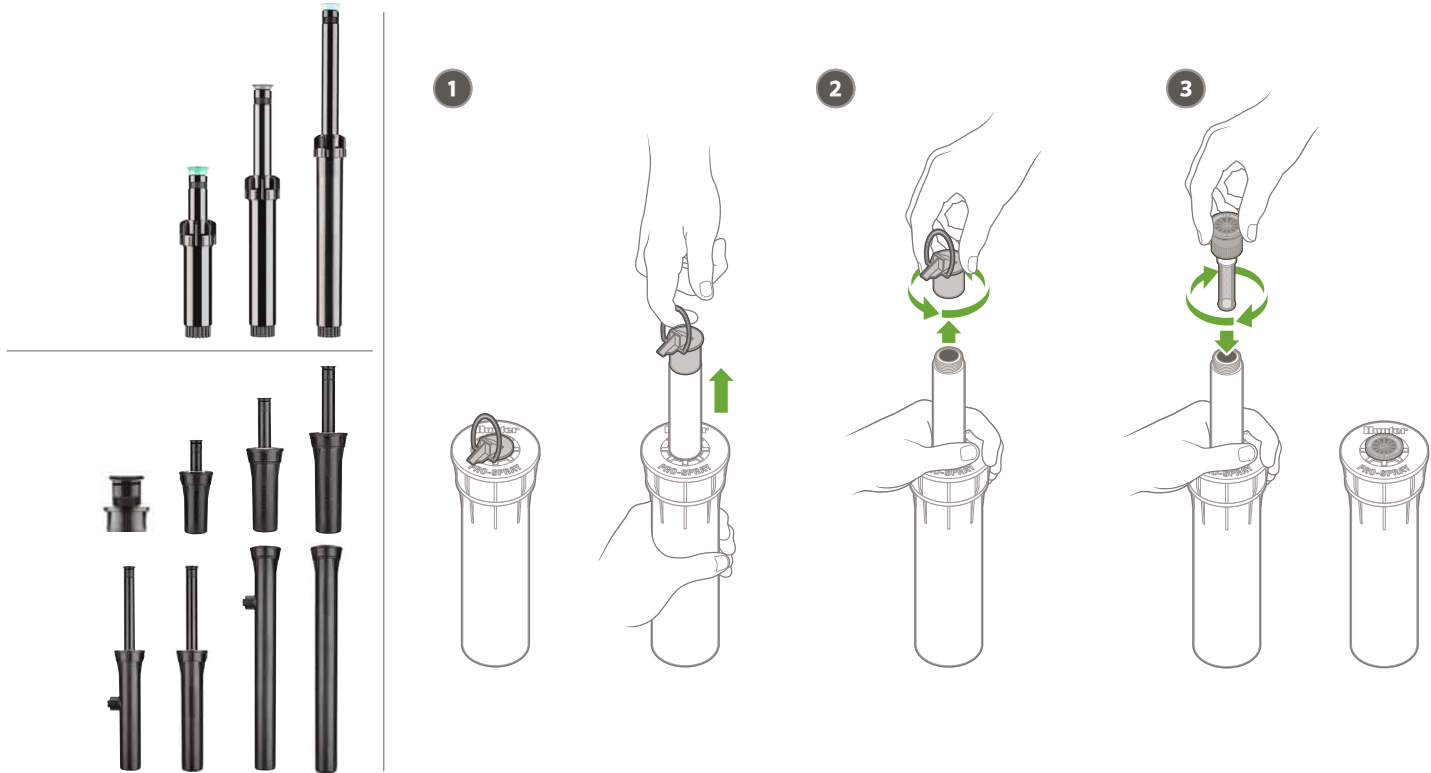

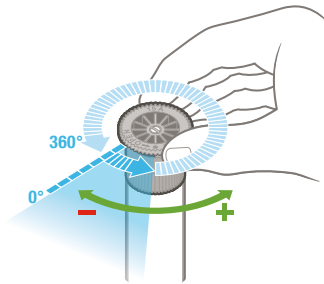

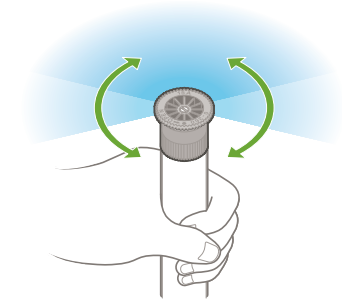

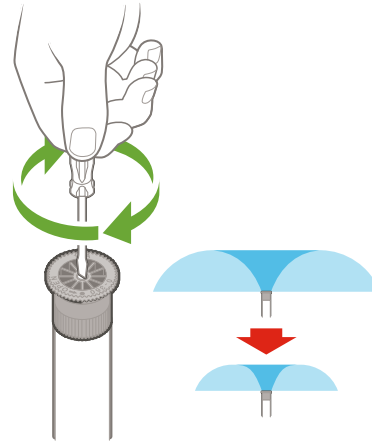

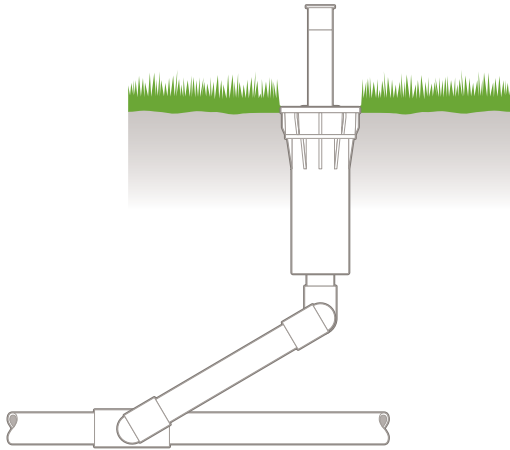







# PS ULTRA / PRO-SPRAY®





 <b>10A</b>	 1.0-3.0 Bar 100-300 kPa 20-40 PSI	 0.7-9.5 l/m 0.2-2.3 GPM	 2.6-3.5 m (9'-11')
 <b>12A</b>	 1.0-3.0 Bar 100-300 kPa 20-40 PSI	 0.7-13.4 l/m 0.3-3.4 GPM	 3.2 m-4.1 m (11'-13')
 <b>15A</b>	 1.0-3.0 Bar 100-300 kPa 20-40 PSI	 1.3-18.0 l/m 0.4-4.5 GPM	 4.0 m-5.2 m (14'-17')
 <b>17A</b>	 1.0-3.0 Bar 100-300 kPa 20-40 PSI	 1.7-21.7 l/m 0.5-5.5 GPM	 4.6 m-5.8 m (16'-19')